

Cole-Parmer®

MP-250 Series

Digital Melting Point Apparatus

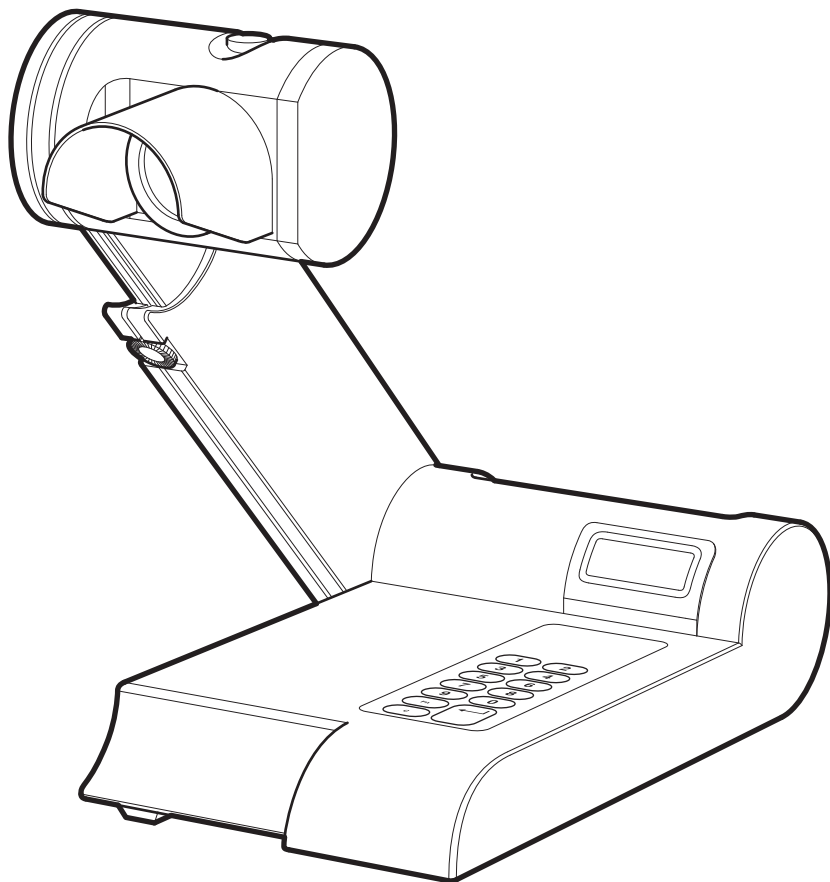

Instruction Manual
ET0001-CPB Version 1.2

Cole-Parmer®
essentials

Contents

Introduction	3
General Description	4
Important Safety Advice	4
Electrical Requirements	5
Before Use	6
Operation	6
Overview	6
Principals of Operation	8
Preparation of Samples	8
Determination of Melting Point	8
Interpretation of Results	9
Setting the Date and Time (MP-250D-P & MP-250D-PR Models Only)	9
MP-250D and MP-250D-F Operation	10
MP-250D-P and MP-250D-PR Operation	11
ECO Mode Settings	14
Calibration Procedure	14
Printer Set-up	14
PC Connection and Hyperterminal use	15
Cleaning and Care	17
In Case of Accidental Spillage	17
In Case of Contamination	17
Servicing and Repair	18
Spares and Accessories	19
Technical Specification	20

Introduction

Thank you for purchasing this Cole-Parmer product. To get the best performance from the equipment, and for your own safety, please read these instructions carefully before use.

Before discarding the packaging check that all parts are present and correct.

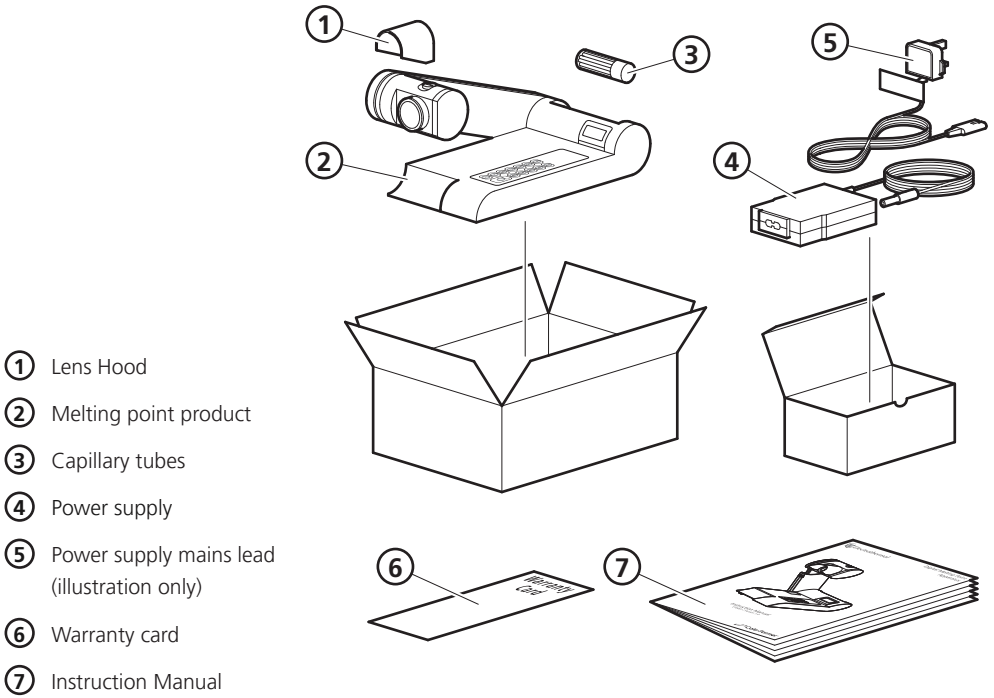

Note: Additional packing material may be present.

This equipment is designed to operate under the following conditions:

- ❖ For indoor use only
- ❖ Use in a well ventilated area
- ❖ Ambient temperature range 5°C to 40°C (41°F to 104°F)
- ❖ Altitude to 2000 m (6500 ft)
- ❖ Relative humidity not exceeding 80%
- ❖ Mains supply fluctuations not exceeding 10% of nominal
- ❖ Overvoltage category II IEC60364-4-443
- ❖ Pollution degree 2 IEC664
- ❖ Use with a minimum distance all round of 200 mm (8 in.) from walls or other items

If the equipment is not used in the manner described in this manual and with accessories other than those recommended by the manufacturer, the protection provided may be impaired.

General Description

Your Cole-Parmer Digital Melting Point Apparatus has been designed for general purpose laboratory use in which samples submitted for analysis are enclosed in a glass capillary tube and brought to a melt point condition under strict controlled parameters of time and temperature.

All of the models within the Melting Point range are operated in a similar manner. An advanced microcontroller and step through menu system accurately control oven temperature and ramp rate. Melt temperatures can be recorded using the ergonomically designed keypad using a single touch keypad entry and 'One Touch' entry / storage.

The MP-250D and MP-250D-F models offer two ramp rates. A quick ramp is provided to define the approximate melt temperature of your sample while the slower ramp rate is provided to accurately attain the true melt temperature of your chemical sample.

The MP-250D-P and MP-250D-PR models contain an internal memory which can be used for storage of run data. These units are able to output data information via the printer, USB flash drive or direct to a host PC using Hyperterminal.

In addition the MP-250D-P and MP-250D-PR units contain the facility to support the following features:-

- ❖ Start of ramp temperature and ramp rate can be touch keypad selected for different test standards.
- ❖ The operating menu system permits batch serial numbers to be allocated via the touch keypad.
- ❖ All stored data enables the reproduction of hard copies which contain the date, time and batch number associated with a built in 'real time' clock.
- ❖ Ceiling temperatures may be set in order to preserve chemicals for analysis should they fail to perform as anticipated.

Daylight balanced LED oven illumination assists in the clear viewing of melt points.



All Cole-Parmer Digital Melting Point Apparatus from Firmware version V0.29 will support Cole-Parmer's ECO mode power saving facility which gives the user the option of setting time out for the oven on/off facility together with the display back light and oven illumination LED's.

Important Safety Advice

This equipment is classified as Class 1 (IEC519:part 2) with regard to over temperature protection and should be used accordingly. Users should be aware of the following safety advice:

- ❖ **SHOCK HAZARDS OR UNSAFE PRACTICES ARE DANGEROUS** as they can cause severe personal injury, fire or death.
- ❖ **DO NOT** use combustible substances near hot objects.
- ❖ **DO NOT** use the equipment in hazardous atmospheres.
- ❖ **DO NOT** operate or handle any part of the product with wet hands or use on surfaces that may become flooded.
- ❖ **NEVER** move the product while still connected to the power supply.
- ❖ **HIGH TEMPERATURES ARE DANGEROUS** as they can cause serious burns to operators and ignite combustible material.
- ❖ **USE CARE AND WEAR PROTECTIVE GLOVES TO PROTECT HANDS.**
- ❖ **NEVER** lift or carry the instrument until it has been switched off and allowed to cool.
- ❖ **DO NOT** position the unit so that it is difficult to disconnect from the mains supply using the mains plug.
- ❖ The mains outlet socket used should be located close to the equipment and readily identifiable and accessible to users.

- ❖ **DO NOT** leave equipment switched on and it is not recommended to leave any heating apparatus unattended during operation.
- ❖ The unit should be carried using both hands.

Symbols Defined



Electrical Requirements



THIS INSTRUMENT MUST BE GROUNDED

Before connection please ensure that the line supply corresponds to the power requirements below:

Model		
MP-250D	45 W	Universal100 – 240 V
MP-250D-F	45 W	Universal100 – 240 V
MP-250D-P	45 W	Universal100 – 240 V
MP-250D-PR	45 W	Universal100 – 240 V

The product is provided with a NEMA 5-15 plug for 120 V installations and a UK 3-pin and a “Schuko” 2-pin plug for 230 V installations.

Should the cable not be suitable for connecting to the power supply, replace the plug with a suitable alternative.

THIS OPERATION SHOULD ONLY BE UNDERTAKEN BY A QUALIFIED ELECTRICIAN.

NOTE: Refer to the equipment rating plate to ensure that the plug and fusing are suitable for the voltage and wattage stated.

The wires in the power cable (120 V) are coloured as follows:

BLACK - HOT/LIVE
 WHITE - NEUTRAL
 GREEN – EARTH

The wires in the power cable (230 V) are coloured as follows:

BROWN - HOT/LIVE
 BLUE - NEUTRAL
 GREEN/YELLOW – EARTH



IF IN DOUBT CONSULT A QUALIFIED ELECTRICIAN

Should the power cable need replacing, a cable of 1mm² of harmonized code H05W-F connected to an IEC320 plug should be used.

The appropriate power cable should be connected BEFORE connection to the power supply.

Before Use

Place the Digital Melting Point Apparatus on a firm, level surface and adjust the lens position so that it is at a convenient viewing angle.



Caution: The heating block may be HOT. As a precaution for the user, all menu screens display the time and current block temperature.

NOTE: If the unit has been used recently the block may be too hot for your sample. If this is the case, press the stop button and allow the unit to cool before proceeding.

Operation

Overview

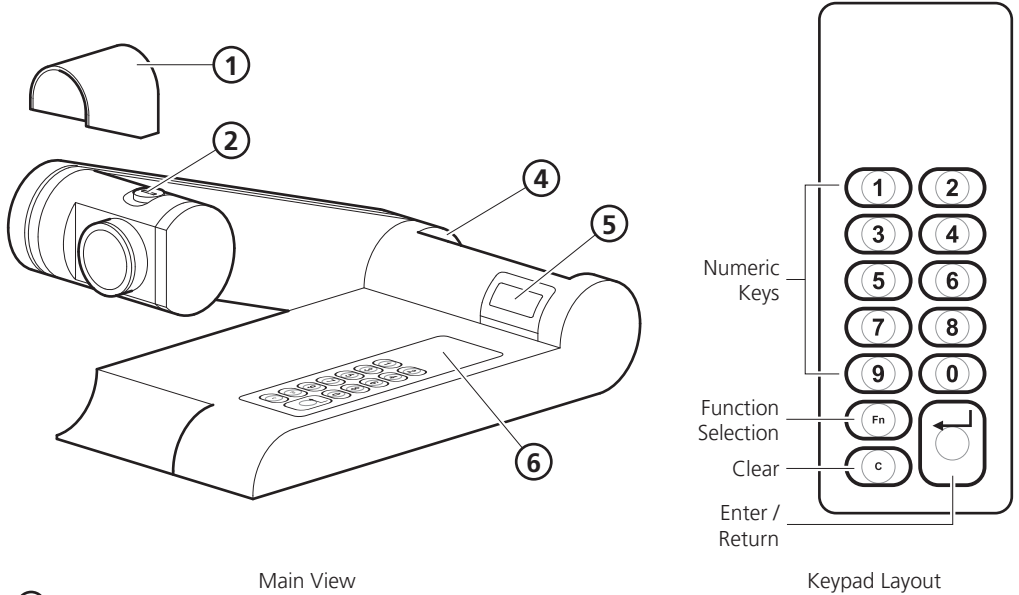

- ① Lens hood
- ② Capillary Guide
- ③ Lens
- ④ Capillary tube holder
- ⑤ 2 x 12 digit display
- ⑥ Keypad

Main View

Keypad Layout

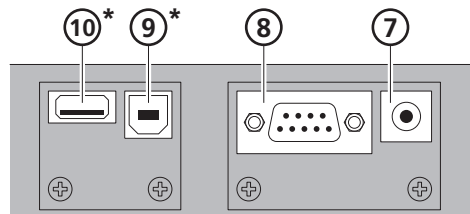

Rear View

- ⑦ Power input
- ⑧ RS232 serial printer connection socket
- ⑨ USB socket type B (Slave) *Not used on MP-250D or MP-250D-F models
- ⑩ USB socket type A (Master) *Not used on MP-250D or MP-250D-F models

1. Connect the mains supply lead and power supply as illustrated.

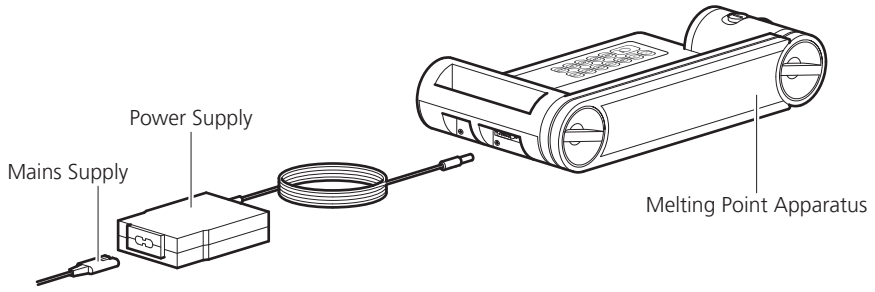

2. The lens hood attachment is optional. Its purpose is to assist in viewing the sample when using in direct light. Slide the lens hood over the threaded back section of the lens as illustrated.

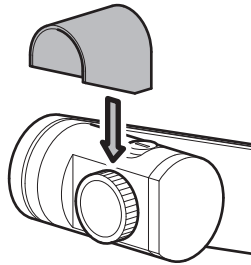

3. Adjust the arm height and oven head angle to suit by loosening the clamp screws and adjusting as required. Re-tighten the clamp screws after making adjustments. Always loosen the clamp screws before making adjustments.

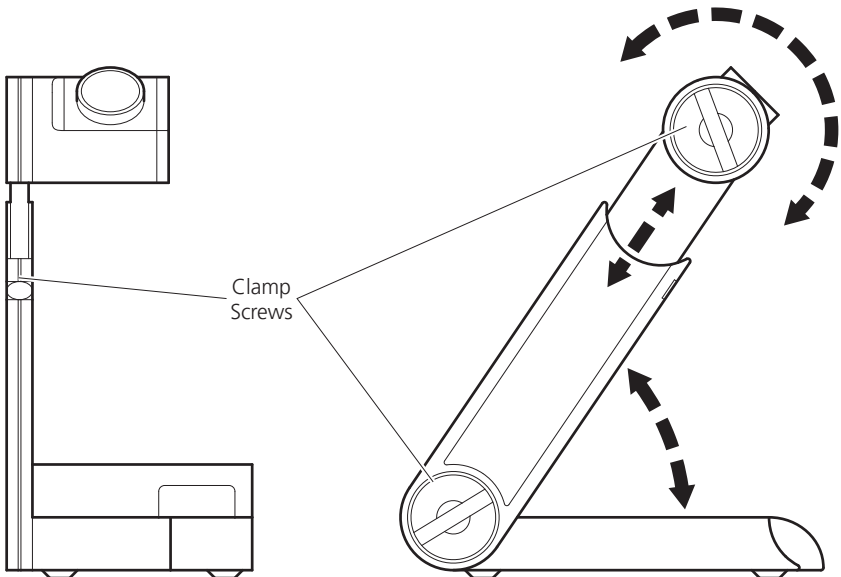

4. Turn on at the mains electrical supply and observe the melting point product through a warm up and self-check routine which include a display of the Model type, the firmware issue release number. Once the clock and date have been set, the MP-250D-P and MP-250D-PR models will display the real time and date during the warm up procedure.

Principals of Operation

During operation, the various parameters of the sample analysis are shown on the liquid crystal display, and all the stages of the process are indicated by the L.E.D. illumination or audible warning.

The principles of the operation are as follows: -

- ❖ Guided by knowledge of the expected melting temperatures of the sample, a 'Set Point' is established and its value keyed in.
- ❖ The oven temperature is driven to meet the 'Set Point' at maximum rate.
- ❖ After a short delay for the oven temperature to stabilize at the 'Set Point', the ramp is activated and the temperature now increases linearly at the much slower ramp rate, during which time the melt analysis takes place.
- ❖ The melting of the sample is observed and the temperatures registered via the keypad at the appropriate time.
- ❖ The melt temperatures (and for the MP-250D-P / MP-250D-PR also the measuring parameters) are now available for review on the display (and for the MP-250D-P & MP-250D-PR a hard copy printed print out, output to USB flash drive or direct download to a PC may be selected).
- ❖ Melt temperature information is now available for review on the display until further melts overwrite existing data or the apparatus is turned off at the mains electric supply.
- ❖ The oven temperature may now be directed to a new 'Set Point' if required for the next analysis.

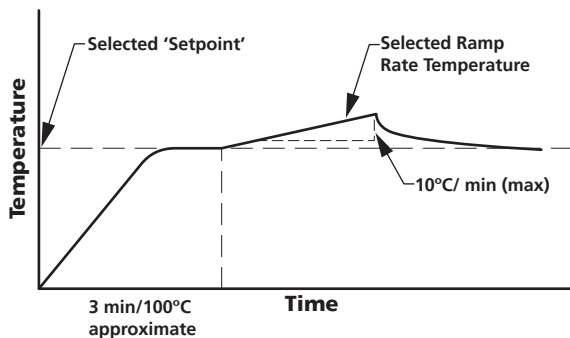

Preparation of Samples

To obtain the best results the samples under melt should be perfectly dry. Drying is best accomplished by storing the samples in vacuum desiccators over a suitable drying agent such as phosphorus pentoxide. Always dry hygroscopic samples.

Provided the sample is dry there is usually little difficulty in introducing a small amount of sample into the capillary tube. Insert the tube into your sample to gather material. Stand the tube upright and then tap the tube on the bench to compact the material at the tube base. It is important not to use too large a sample, a quantity occupying no more than 1-2 mm of the bottom of the tube is ample. If this is exceeded accurate and sharp melt reading points may not be obtained. Care should be taken to see the sample beds down to the bottom of the tube as large air pockets can cause false melt observations.

Note: Sample preparation should be undertaken independently of the apparatus.

Determination of Melting Point

In recording melting points, the operator may wish to observe four distinct phases:

- First signs of change (darkening, shrivelling, sintering, etc.). These changes may be due to loss of solvent or crystallization. Occasionally one can see the solvent condensing on the cooler portion of the tube.
- First signs of liquid formation.

- c. Formation of meniscus.
- d. Formation of a completely clear liquid.

Not all compounds will behave in this manner however. With many, especially where the material is in a high state of purity, no change may be seen before any liquid appears. Some materials will be seen to sublime, rather than melt above 300°C.

Decomposition may often be accompanied by evolution of gas.

Pure compounds will be expected to pass through the 3 stages a) c) and d), within a range of 1°C.

Interpretation of Results

It is generally accepted the formation of a meniscus should be regarded as the figure to be recorded for a single temperature melting point. Where a range is quoted, it can generally be assumed reference is being made to stages b) to d) inclusive. The range will generally cover no more than 1°C for pure compounds, but may well extend to 3 or 4°C for others. The range will often be greater when decomposition or sublimation is experienced. When using the equipment to determine the melting point of more than one sample of the same compound at a time, the average of the meniscus temperature (onset of melt) should be taken.

Setting the Date and Time (MP-250D-P & MP-250D-PR Models Only)

Date and time settings may also be accessed via the (F3) function facility.

Note: The time clock has no daylight-saving facility. You may wish to re-set the time when daylight saving takes place.

When either the MP-250D-P / MP-250D-PR is plugged in and powered up for the first time, the time and date may require setting. After the unit has displayed the firmware version and model type you will be asked to set the date and the time. Press the return key to take you to the setting functions.



You are now asked to select the date format. Select the required format by pressing either key 1 or key 2.

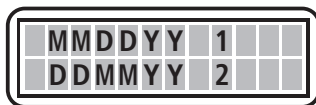

Enter the characters of the date for the format selected. For date selection 1 enter the following as an example. To enter 14th July 2010 press 071410. For date selection 2 enter the following using the same example 140710.

You will now be prompted to select the time format of either 12 or 24-hour format. Press key 1 for 12-hour format or press key 2 for 24-hour format.

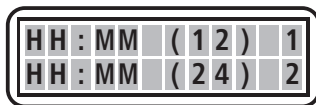

Enter the time characters for the time in your time zone as directed by the screen followed by the return key. If you have selected the 12-hour time format you will now be asked to select whether your time is set in AM or PM mode. Select the prompt key 1 or 2 as applicable.

Your IA will return to the user screen.

MP-250D and MP-250D-F Operation

Connect the melting point apparatus to the power supply. It will perform a self-check while displaying the model and firmware version. The display will then turn to the Home screen which says 'Ready' and shows the ovens current temperature.



F1 is the Home screen for setting temperatures and running. Press 'Fn' key to enter the F2 screen. The F2 screen will display the details of the last performed melt sequence. To toggle between F1 home screen and F2 Melt recall screen press the 'Fn' key.

To commence melt setup and perform a melt sequence, ensure the unit is in the F1 home screen. Press the return key.

You are now asked to 'Set the Temperature'. Use the key pad to enter the required set point temperature. Refer to 'Principals of Operation' (page 8). Once the desired set point temperature has been entered press the return key.



You are now asked to select your preferred ramp rate. Press 1 for 1.0°C/min or 2 for 10.0°C/min.

Note: The default ramp rate is set at 1.0°C/min.

MP-250D-F Only: You are now given the option to set the ceiling temperature. The ceiling temperature should only be set if it is critical to your sample that it must not be heated above a certain temperature. The default is 400°C. If there is no requirement for setting a ceiling temperature press the return key. The oven will commence heating to the set point temperature.

Note: The last used ceiling setting will be remembered and recalled for subsequent melts. If the oven is powered down and then powered up again the default value of 400°C will be reinstated.

Note: The ceiling temperature cannot be set to less than 5°C above the set point temperature. If you attempt to make an illegal setting the oven will automatically default to 5°C above the set point temperature.

As the apparatus heats up to the set point temperature you will see four asterisks appear across the lower half of the display screen indicating the closeness of the oven temperature to the set point temperature. When the set point temperature has been reached, the apparatus will beep three times and all four asterisks will stop flashing and be on constantly. It is recommended the user allows a short time of a couple of minutes for the oven temperature to stabilize before commencing with the ramp heating.

Insert your chemical samples and allow the apparatus and chemicals to stabilize once more. Press the return key to commence ramping.

When the first melt is observed press the return key. Up to four melts may be performed as described in 'Determination of Melting Point' (page 8). Press the return key every time a melt is observed. If less than four melts are required press the 'Fn' to move out of melt record mode.

You are now asked if you wish to turn off the oven. Press key 1 for yes or key 2 for no. If you are going to perform subsequent melts, then leave the oven on. It will reset back to the previous set point temperature.

Reading the Recorded Melt Data: From the home screen press the 'Fn' key to enter F2 Melt recall screen. Press the return key to display the melt point data of the first date. Press the return key to display the temperature of the second melt recorded and so on for the third and fourth melts. To exit the screen press 'Fn' twice to return to the Home screen.

Note: Only the last recorded batch may be viewed. Previous melt data will be over written.

Note: Data will be lost if the oven is turned off or disconnected from the electrical supply.

MP-250D-P and MP-250D-PR Operation

Connect the IA to the power supply. It will perform a self check while displaying the model, date and firmware version. The display will then turn to the home screen which says 'Ready' and shows the IA ovens current temperature.



Function Key Operation (Fn): The function key is used for scrolling through the sub menus. Each time the Fn key is pressed the IA will enter the next sequential function screen. The main home screen is F1 from which settings are made and melts are performed. From F1 press the Fn key and the sub menu F2 'Stored data' appears. The F2 sub menu is used for recalling saved melt information together with selecting data output methods. From F2 press the Fn key to access F3 the sub menu, the settings menu. Within the settings function the time clock can be accessed to make adjustments to the date and time. If you press the Clear 'C' key from F2 or F3, you will return to the F1 home screen.

F1 Operational Mode

You are now asked to 'Set the Temperature'. Use the key pad to set the set point temperature. Refer to 'Principals of Operation' (page 8). Once the desired set point temperature has been entered press the return key.



You are now asked to set the ramp rate. The MP-250D-P default is 0.2°C/min and the MP-250D-PR default is 1.0°C/min. To change the ramp rate use the keypad to enter the new ramp rate value. Press the return key to accept the default or accept the new ramp rate value.

Note: The last used ramp rate setting will be remembered and recalled for subsequent melts. If the IA is powered down and then powered up again the default value will be reinstated.

You are now given the chance to set the ceiling temperature. The ceiling temperature should only be set if it is critical to your sample so that it must not be heated above a certain temperature. The default is 400°C. If there is no requirement for setting a ceiling temperature press the return key. The IA oven will commence heating to the set point temperature.

Note: The last used ceiling setting will be remembered and recalled for subsequent melts. If the IA is powered down and then powered up again the default value of 400°C will be reinstated.

Note: The ceiling temperature cannot be set to less than 5°C above the set point temperature. If you attempt to make an illegal setting the IA will automatically default to 5°C above the set point temperature.

As the apparatus heats up to the set point temperature you will see four asterisks appear across the lower half of the display screen indicating the closeness to the set point temperature. When the set point temperature has been

reached the apparatus will beep three times. It is recommended the user allows time for the oven temperature to stabilize before commencing with the ramp heating.

Insert your chemical samples and allow time for the oven to reheat back to the set point temperature and re-stabilize. Press the return key to commence ramping. You will notice a moving icon indicating that the IA is in ramping condition.

For the MP-250D-P: When the first melt is observed press the return key. Up to 4 melts may be performed. Refer to 'Determination of Melting Point' (page 8). Press the return key every time a melt is observed. If less than four melts are required press the 'Fn' to move out of melt storage mode.

For the MP-250D-PR: When the first melt is observed press the return key to register the melt. Then to identify the oven position press either 1 for left, 2 for central or 3 for the right hand oven position. Two melts may be recorded for each oven position. You will observe a figure M1 appearing next to selected oven position indicating that a melt has been saved to that oven position. A figure M12 will indicate a second melt has been saved against the selected oven position. In addition a red LED indicating the saved melt oven position can be observed through the viewing lens. Refer to 'Determination of Melting Point' (page 8). Press the return key every time a melt is observed. When sufficient melts have been recorded, press the 'Fn' to move out of melt storage mode.

You are now asked if you wish to turn off the oven. Press key 1 for yes or key 2 for no. If you are going to perform subsequent melts then leave the oven on. It will reset back to the previously set plateau temperature.

You are now asked if you wish to store the melt data. Press 1 for yes or 2 for no. If the answer is yes you will be asked to enter a batch number. If using the MP-250D-P, select a batch number between 1 and 1000, alternatively for the MP-250D-PR select a batch number between 1 and 500, then press the return key. After making store data decision you are taken to the recorded data option screen.

You are now asked if you wish to view the recorded melt data. Press 1 for yes or 2 for no. If you have selected yes, press the return key to scroll through the data settings and recorded melt data. If you pressed no you are taken straight to the printing option screen.

You are now asked if you wish to print out the recorded data. Press 1 for yes or 2 for no. Ensure a printer is connected before selecting 1 for a print. Refer to 'Printer Set-up' (page 14).

You are now asked if you wish to output the data via a USB Pen drive. Press 1 for yes or 2 for no. If you press 1 for yes you are asked to insert a USB Pen drive. Your data will be uploaded to the Pen drive device. Data written to the Pen drive can be accessed on your PC using MS 'Notepad' or similar application. The file name is IAxxxx where xxxx is the batch number.

You are asked if you want to send the melt data direct to your PC. Press 1 for yes or 2 for no. Ensure your IA is connected to your PC using the USB slave socket. Refer to 'Overview, Rear View illustration' and item 9 USB socket type 'B' Slave (page 6). The IA is accessed via HyperTerminal on your PC. Refer to 'PC Connection and Hyperterminal use' (page 15).

Finally you are asked if you wish to retain the settings. (Only available if the oven has not been turned off). Press key 1 for yes or key 2 for no. This feature allows the user to return straight back to performing subsequent melts without the option of making adjustments to the melt profile. Refer to 'F1 Operational Mode' (page 11). Use this facility when there are lots of melts to be performed and the previously set temperature, ramp rate and ceiling temperature are required for all. This facility cuts down on key entry and assists in speeding up the melt throughput. When 1 is selected the IA will return to the plateau temperature. The 4 asterisks will appear on the display as an indication of the closeness to temperature plateau. When the IA beeps and 4 asterisks are displayed, press the return key to commence ramping. By pressing the 2 = no key the user is taken back to the F1 home

screen where upon melt profile adjustment can be made.

F2 Reviewing and Outputting Stored Data

From the F1 home screen press the 'Fn' key to enter F2 Stored data screen. Press the return key to accept access.

Enter the batch number using the keypad. Press the keypad return key.

The IA now says Display. This allows both settings and melt data to be viewed on the display. Press 1 for yes or 2 for no. If 1 = yes is selected you will see the following information below. Press the return key to view the next field.

For the MP-250D-P:

- ❖ Date and first melt recorded time.
- ❖ The set Ramp rate.
- ❖ M1 melt temperature.
- ❖ M2 melt temperature (assuming it was recorded).
- ❖ M3 melt temperature (assuming it was recorded).
- ❖ M4 melt temperature (assuming it was recorded).

For the MP-250D-PR:

- ❖ Date and first melt recorded time.
- ❖ The set Ramp rate.
- ❖ Melt temp 1.1 Red LED visible through the lens in the left hand position.
- ❖ Melt temp 1.2 (assuming it was recorded). Red LED visible through the lens in the left hand position.
- ❖ Melt temp 2.1 (assuming it was recorded). Red LED visible through the lens in the center position.
- ❖ Melt temp 2.2 (assuming it was recorded). Red LED visible through the lens in the center position.
- ❖ Melt temp 3.1 (assuming it was recorded). Red LED visible through the lens in the right hand position.
- ❖ Melt temp 3.2 (assuming it was recorded). Red LED visible through the lens in the right hand position.

To exit view melt data without viewing all the stored data press the 'Fn' to sequence into the printing option.

To exit viewing the melt data and return to F2 screen in order to view another stored batch press the 'C' key.

You are now asked if you wish to print out the recorded data. Press 1 for yes or 2 for no. Ensure a printer is connected before selecting 1 for a print.

You are now asked if you wish to output the data via a USB Pendrive. Press 1 for yes or 2 for no. If you press 1 for yes you are asked to insert a USB flash drive. Your data will be uploaded to the flash drive. It can be read on your PC using 'Notepad'.

You are asked if you want to send the melt data direct to your PC. Press 1 for yes or 2 for no. Ensure your IA is connected to your PC using the slave socket.

You are asked if you wish to delete stored data. Press 1 for yes or 2 for no. You are now returned to the F1 home screen.

F3 Setup Mode

From the F1 home screen press the 'Fn' key twice to enter F3 setup mode screen. Press the return key to accept access.

Time and date settings and adjustments are made here. Refer to 'Setting the Time and Date (MP-250D-P & MP-250D-PR Models Only - page 9).

ECO Mode Settings



ECO Mode is provided to save on power when the keypad remains untouched for a pre-specified length of time. The default setting is one hour, for instructions on how to adjust ECO Mode please contact Antylia Scientific quoting your model and serial number or visit www.coleparmer.com.

Calibration Procedure

This instrument can be recalibrated and adjusted by an end user. Please contact Antylia Scientific for details of the procedure quoting your model and serial number or visit www.coleparmer.com.

Printer Set-up

PR2000S model printer is set as follows:

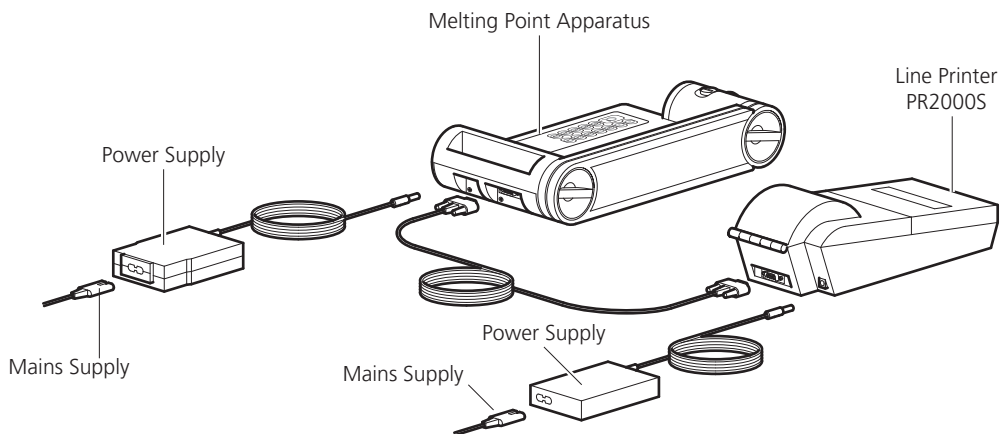

The PR2000S serial printer is set up for compatibility with the IA. The Baud rate on the PR2000S printer is factory set at 9600.

If using a printer that has been used from a previous model of IA the baud rate must be changed to 9600. To make local settings on the printer, the printer must be put in 'program mode'.

Press the '□' and the '1' button simultaneously. The printer will now enter 'PROGRAMMER MODE'.

The following text will be printed.

"DATA/PAR'Y :- 8/NONE"

Press the 'PAPER' feed button.

The following text will be printed.

"Xon/Xoff :- ON"

Press the 'PAPER' feed button.

The following text will be printed.

"BAUD RATE :- 9600"

Press the '□' and 'PAPER' feed buttons simultaneously.

The PR2000S will produce a print of the stored settings which will be as follows:

SETUP COMPLETE	: -	
Data/Par'y	: -	8/NONE
Xon/Xoff	: -	On
Baud rate	: -	9600
Country	: -	UK
Print mode	: -	Text
Auto-off	: -	5 min
Emulation	: -	Standard
DTR	: -	Normal
Interface	: -	Serial
Mechanism	: -	M190

PC Connection and Hyperterminal use

From the Window's 'Start' button, select Programs/Accessories/communications/hyperterminal.

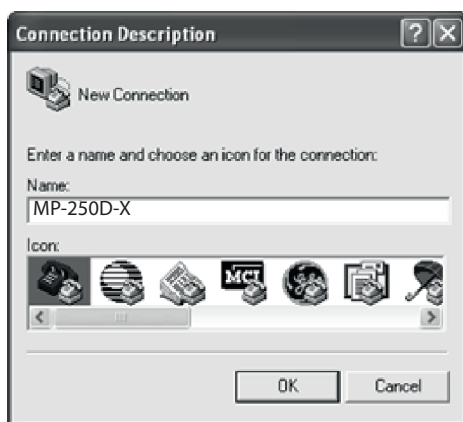

Enter name for connection (example MP-250D-X). Select the phone icon  and click OK.



From the pull-down menu select the port number applicable to your PC for the USB terminal in use.

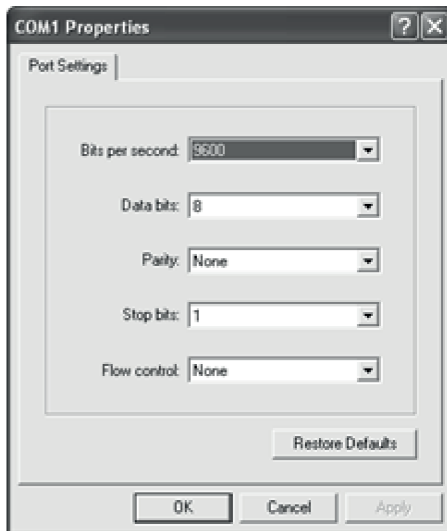

Make sure the port settings are as detailed below.

Baud rate = 9600

Data bits = 8

Parity = None

Stop bits = 1

Flow control = None

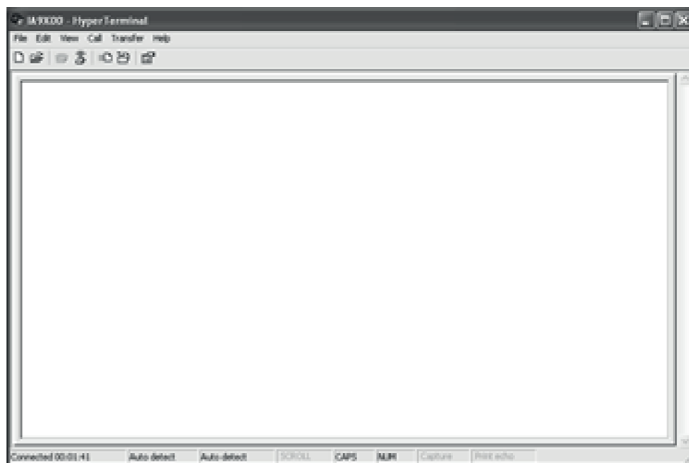

Your print data will be shown in window.

Any serial terminal emulator with USB support can be used. An example of which is given below.

If your PC doesn't have hyperterminal pre-installed, a copy may be obtained from

<http://www.hilgraeve.com/hyperterminal/>

Cleaning and Care



HOT: Before attempting cleaning, ensure that the unit is cool, and disconnect from the power supply.



WARNING: Ensure the unit is disconnected from the power supply before attempting maintenance or servicing.

With proper care and operation, the equipment should give reliable service, however contamination or general misuse may reduce the effective life of the product and could cause a hazard.

Preventative maintenance should include keeping the product clean by protecting it from spillage, contamination or corrosive environments. If in doubt, please confirm that any intended method of decontamination will not damage the equipment by contacting Antylia Scientific.

NOTE: Do not use solvents for cleaning any parts of this equipment.

In Case of Accidental Spillage



WARNING: DO NOT TOUCH IF A SPILLAGE/BREAKAGE HAS OCCURRED. DISCONNECT THE POWER DIRECTLY AT THE POWER SUPPLY SOURCE.

If the equipment has been exposed to liquid, it cannot be assumed to meet all the safety requirements of EN 61010-2-010 until the drying out process has been fully completed and all safety requirements are met before the unit is used again.

In Case of Contamination



WARNING: THE FOLLOWING PROCEDURE IS INTENDED AS A GUIDE. SHOULD SPILLAGE OF A TOXIC OR HAZARDOUS FLUID OCCUR, THEN ADDITIONAL SPECIAL PRECAUTIONS MAY BE NECESSARY.

If the equipment has been exposed to contamination, the Responsible Body is responsible for carrying out appropriate decontamination. If hazardous material has been spilt on or inside the equipment, decontamination should only be undertaken under the control of the Responsible Body with due recognition of possible hazards. Before using any cleaning or decontamination method, the Responsible Body should check with the manufacturer that the proposed method will not damage the equipment. Prior to further use, the Responsible Body shall check the electrical safety of the unit. Only if all safety requirements are met can the unit be used again.

NOTE: In the event of this equipment or any part of the unit becoming damaged or requiring service, the item(s) should be returned to the manufacturer for repair accompanied by a decontamination certificate. Copies of the Certificate are available from the Distributor/Manufacturer.

At the end of its service life, the product must be accompanied by a Decontamination Certificate.

Servicing and Repair

This product range does not require any routine servicing, but in case of accidental spillage, instructions for cleaning and decontamination are also included. Routine maintenance should include inspection of the power supply unit and mains power lead set.

NOTE: There are no internal user replaceable parts.

NOTE: Periodic electrical safety testing is recommended on a yearly schedule or immediately after any servicing to ensure safe operation.

In the event of product failure, it is recommended that any repair is only undertaken by suitably qualified personnel. For advice, please contact Antylia Scientific quoting the model and serial number. Only spare parts supplied by the manufacturer or its agent should be used. Fitting of non-approved parts may affect the performance of the safety features of the instrument.

If in doubt, please contact:

Antylia Scientific Ltd.

Beacon Road,

Stone, Staffordshire,

ST15 0SA, United Kingdom

Tel: +44 (0)1785 812121

Email: cp-service@antylia.com

Web: www.coleparmer.com

Spares and Accessories

Spares

IA9100/MPCBA	Main PCB Assembly MP-250D-F / MP-250D
IA9200/MPCBA	Main PCB Assembly MP-250D-P / MP-250D-PR
IA9100/DPCB	Display PCB MP-250D-F / MP-250D-P / MP-250D-PR / MP-250D
SA135109	Lens Assembly MP-250D-F / MP-250D-P / MP-250D-PR
SA135109/2	Lens Assembly MP-250D
IA9100/OA	Oven and Arm Assembly MP-250D-F / MP-250D-P
IA9300/OA	Oven and Arm Assembly MP-250D-PR
MELT/OA	Oven and Arm Assembly MP-250D
IA9100/OPCBA	Oven Back Light PCB Assembly MP-250D-F / MP-250D-P / MP-250D-PR / MP-250D
135116	Capillary Tube Guide MP-250D-F / MP-250D-P / MP-250D-PR / MP-250D
136526	Light Hood MP-250D-F / MP-250D-P / MP-250D-PR
135162	IA Keypad MP-250D-F / MP-250D-P / MP-250D-PR
136526/2	Light Hood MP-250D
135162/2	MP-250D Keypad MP-250D
IA9100/FOOT	Foot Kit MP-250D-F / MP-250D-P / MP-250D-PR / MP-250D
SA135179	PT100 Sensor IA Oven MP-250D-F / MP-250D-P / MP-250D-PR / MP-250D
AZ9219	PSU 100-240 V ~ 50/60Hz
HH179(S)	UK Mains Lead Moulded Plug
HH180(S)	European Mains Lead with Plug
CRM6288	US Moulded Plug/Lead Set

Accessories

AZ9001	Cold Finger
MP-250-CK	Calibration key
SMP-KIT	Calibration chemicals Vanillin, Sulphanilamide and Caffeine
AT4042	Capillary Tubes 1.5mm (10x100 packs)
AT4043	Capillary Tubes 2.0mm (10x100 packs)
AT4044	Paper Roll (2) and ribbon for printer
PR2000S	Printer (with connecting ribbon cable)

Technical Specification

Features	MP-250D	MP-250D-F	MP-250D-P	MP-250D-PR
32-bit processor	●	●	●	●
3 capillary tubes up 2mm OD (storage for pack)	●	●	●	●
Tube guide removal for cleaning and use of cold finger	●	●	●	●
40mm dia. lens (magnification x 8) removable and with adjustable focus	●	●	●	●
13 – key membrane keypad	●	●	●	●
Sample preservation ceiling temperature selection		●	●	●
White 3 x Super Flux LED's	●	●	●	●
Selectable ramp rate of 1.0°C/min or 10.0°C/min	●	●		
Selectable ramp rates of 0.2°C/min to 10.0°C/min in increments of 0.1°C/min			●	●
Date and time facility			●	●
PC output facility			●	●
Printer output facility			●	●
USB output to Pen key			●	●
4 x 1 Melt memory capacity	●	●	●	
3 x 2 Melt memory capacity				●
Batch memory capacity of 500 melts				●
Batch memory capacity of 1000 melts			●	
Serial printer connection facility			●	●
Pack of 100 capillary tubes	●	●	●	●

Electrical specification	MP-250D	MP-250D-F	MP-250D-P	MP-250D-PR
Total power consumption	45 W			
Oven control	Closed loop P.I.D.			
Oven illumination	3 x white Super Flux LED's			
Illuminous Intensity (per LED)	3500 Lux			
Oven operating temperature range	Ambient +5°C to 400°C			
Power supply PSU When ordering a replacement PSU, always quote the instrument's serial number.				
Input voltage	100-240 V ~ 50/60Hz			
Output voltage	15V DC			

General Specification	MP-250D	MP-250D-F	MP-250D-P	MP-250D-PR
Temperature display range	1°C to 405°C			
Display resolution	1.0°C	0.1°C		
Accuracy	± 1°C of set temperature	± 0.5°C @ 20°C linearly to ± 1.0°C @ 350°C		
Ramp rate	N/A	1.0°C/min or 10.0°C min selectable	From 0.2°C/min to 10.0°C/min settable in increments of 0.1°C/min	
Ceiling temperature setting	From 5°C above set temperature to 405°C in increments of 1°C			
Time and date	N/A		Settable with date display as MMDDYY or DDMMYY. Time selectable in 12 or 24-hour format	
Display	12 x 2 backlit matrix LCD			
Control Sensor	Platinum Resistance Probe (PT100).			

Weights and Dimensions

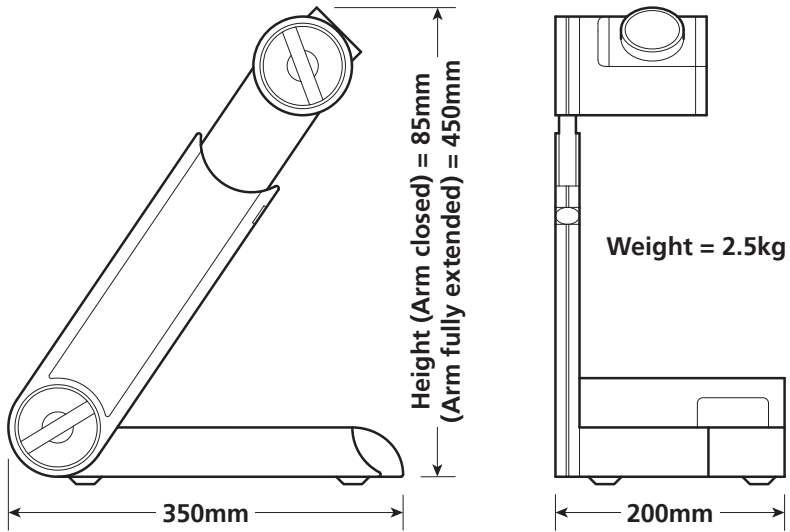

NOTES



This product meets the applicable CE Directives and UKCA Legislation for radio frequency interference and may be expected not to interfere with, or be affected by, other equipment with similar qualifications. We cannot be sure that other equipment used in its vicinity will meet these standards and so we cannot guarantee

that interference will not occur in practise. Where there is a possibility that injury, damage or loss might occur if equipment malfunctions due to radio frequency interference, or for general advise before use, contact the manufacturer.

Declaration of Conformity is available to view online at www.coleparmer.com

EU Representative address

Antylia Scientific GmbH
Futtererstraße 16
97877 Wertheim
Deutschland
Tel: +49 9377 9203-0
Email: sales@coleparmer.de

UK Representative address

Antylia Scientific
9 Orion Court
Ambuscade Road
Colmworth Business Park
St. Neots
PE19 8YX
United Kingdom
Tel: +44 (0) 1480 277339
Email: enquiries@antylia.com



WolfLabs

Pricing on any accessories shown can be found by keying the part number into the search box on our website.

The specifications listed in this brochure are subject to change by the manufacturer and therefore cannot be guaranteed to be correct. If there are aspects of the specification that must be guaranteed, please provide these to our sales team so that details can be confirmed.

www.wolflabs.co.uk

Tel : 01759 301142

Fax : 01759 301143

sales@wolflabs.co.uk

Please contact us if this literature doesn't answer all your questions.